

DIN VDE 0710 TEIL 1

PANEL CUT
MONTAJ ÖLÇÜSÜ

0.8-3mm

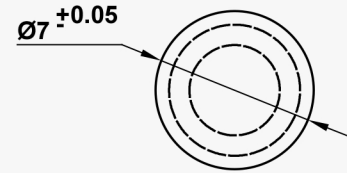
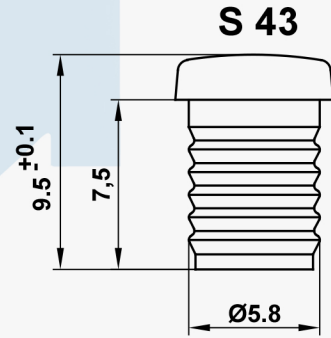
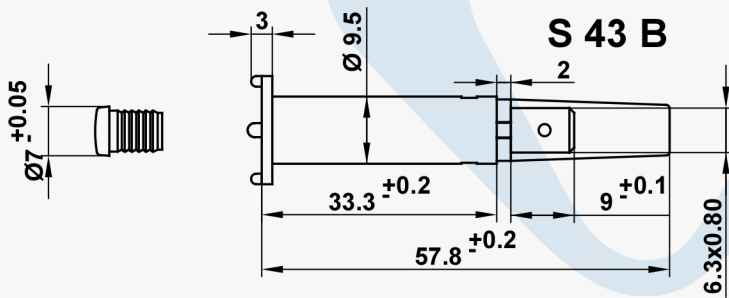
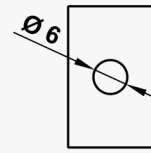
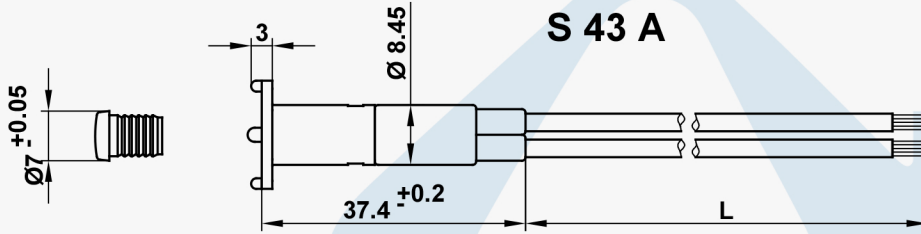

AN-EL ANAHTAR VE ELEKTRİKLİ EV ALETLERİ SANAYİ A.Ş.

TELEFON : +90 216 307 74 01

<http://an-el.com.tr> info@an-el.com.tr

S 43 A

SİNYAL LAMBALARI