

DIN VDE 0710 TEIL 1

PANEL CUT
MONTAJ ÖLÇÜSÜ

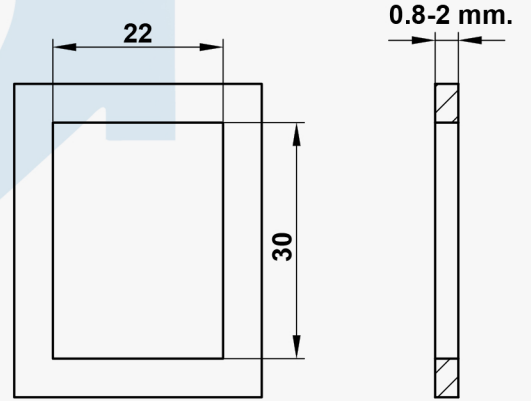
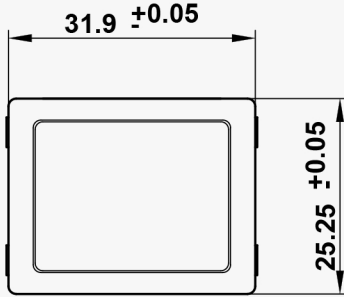

AN-EL ANAHTAR VE ELEKTRİKLİ EV ALETLERİ SANAYİ A.Ş.

TELEFON : +90 216 307 74 01

<http://an-el.com.tr> info@an-el.com.tr

S 45

SİNYAL LAMBALARI